

**10 dBi Gain, 9.84-15 GHz, WR75 Standard Gain Horn with UBR120 Flange**

Rev 2

**Electrical**

Frequency Range	9.84-15 GHz
Norminal Gain	10 dBi
Polarization	Linear
VSWR	1.25 max
3dB Beamwidth	H-Plane: 34.6~51.7 deg, E-Plane: 36.0~57.7 deg
Operating Temperature	-40°C~+70°C

**Mechanical**

Waveguide Size	WR75
Flange Type	UBR120 Square Cover Flange
Body Material and Finish	Aluminum, Painted

**Dimensions(mm)**

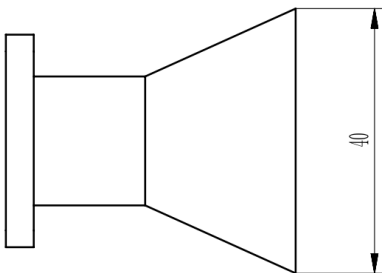
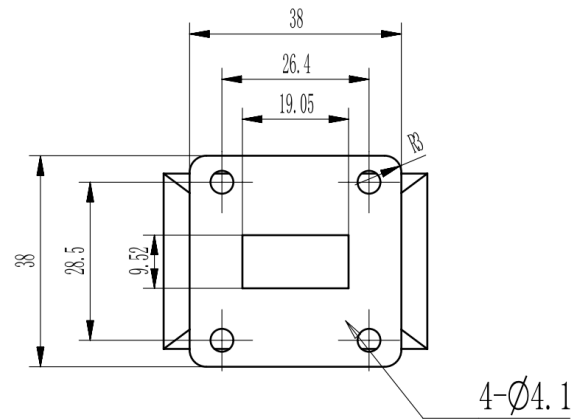
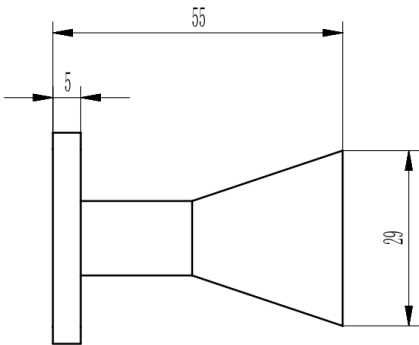

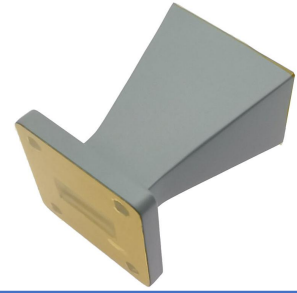

**10 dBi Gain, 9.84-15 GHz, WR75 Standard Gain Horn with UBR120 Flange**

Rev 2

**Typical Test Data**

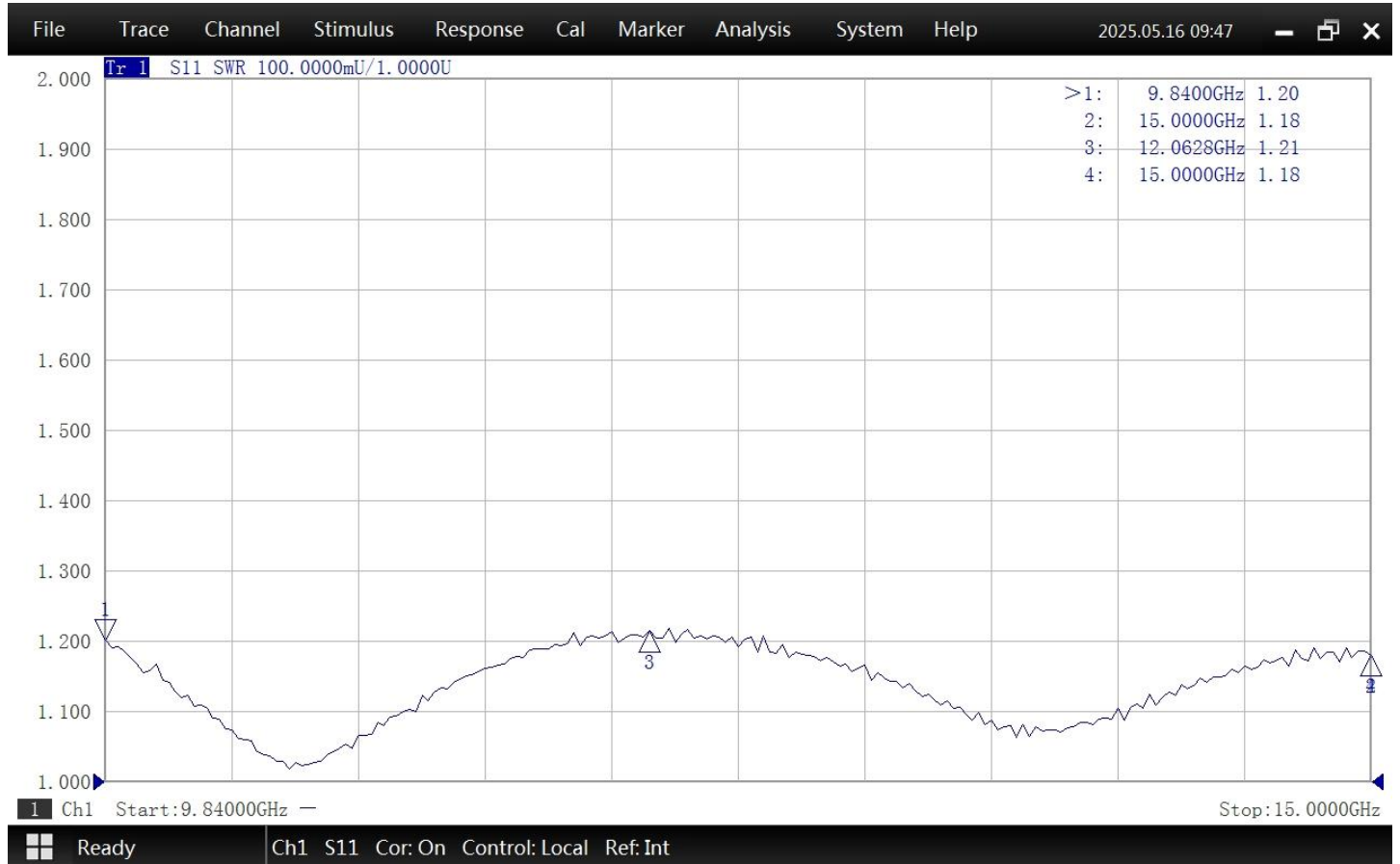

# Simulated Antenna Patterns

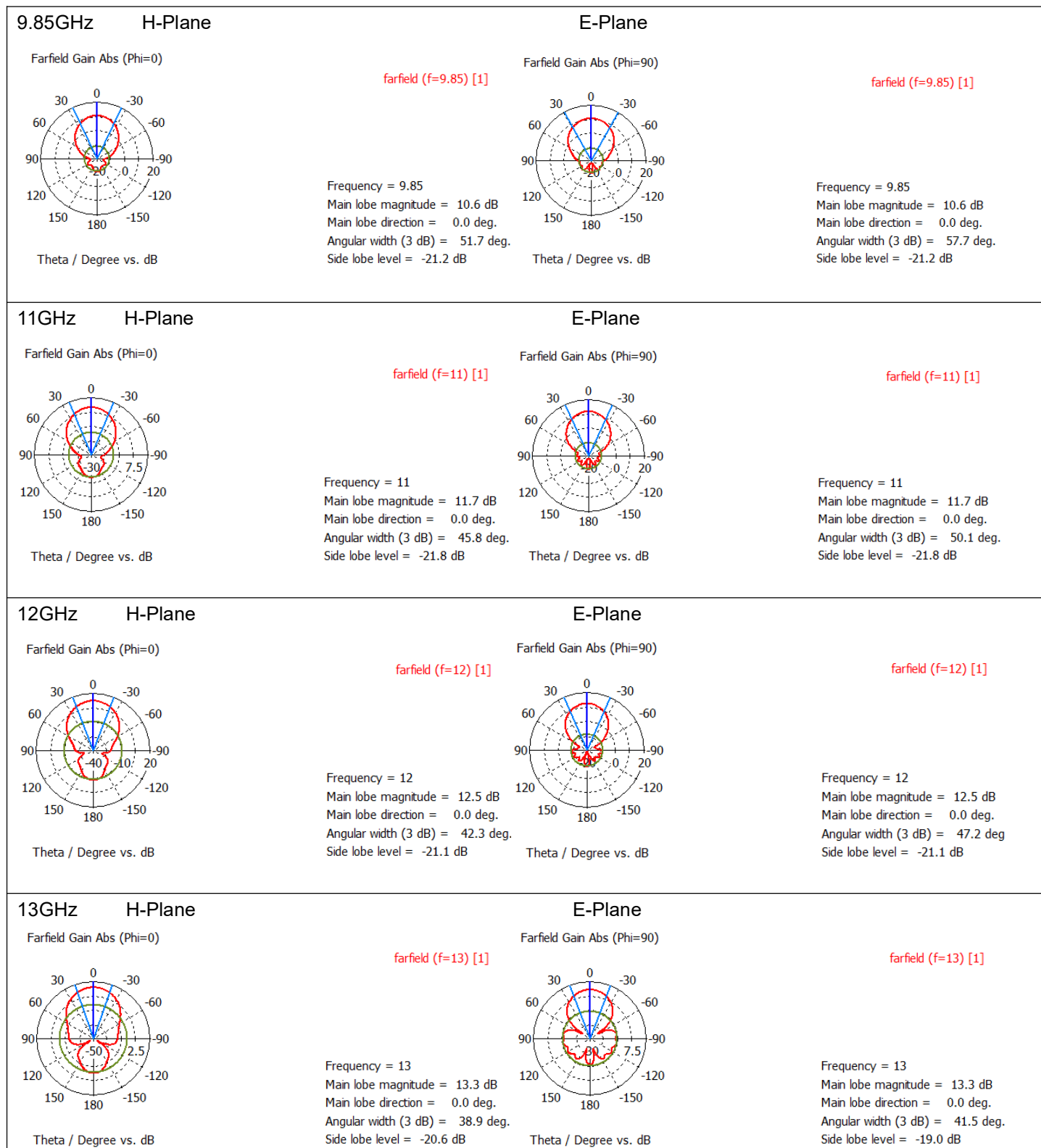

14GHz H-Plane

Farfield Gain Abs (Phi=0)

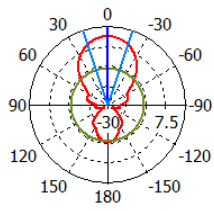

Theta / Degree vs. dB

farfield (f=14) [1]

Frequency = 14  
 Main lobe magnitude = 14.0 dB  
 Main lobe direction = 0.0 deg.  
 Angular width (3 dB) = 36.2 deg.  
 Side lobe level = -20.1 dB

E-Plane

Farfield Gain Abs (Phi=90)

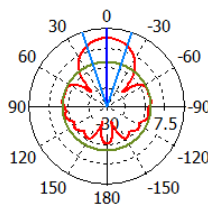

Theta / Degree vs. dB

farfield (f=14) [1]

Frequency = 14  
 Main lobe magnitude = 14.0 dB  
 Main lobe direction = 0.0 deg.  
 Angular width (3 dB) = 37.1 deg.  
 Side lobe level = -15.3 dB

15GHz H-Plane

Farfield Gain Abs (Phi=0)

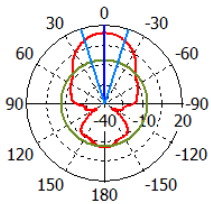

Theta / Degree vs. dB

farfield (f=15) [1]

Frequency = 15  
 Main lobe magnitude = 14.0 dB  
 Main lobe direction = 0.0 deg.  
 Angular width (3 dB) = 34.6 deg.  
 Side lobe level = -20.0 dB

E-Plane

Farfield Gain Abs (Phi=90)

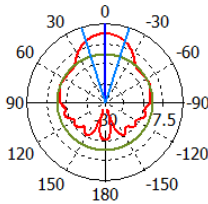

Theta / Degree vs. dB

farfield (f=15) [1]

Frequency = 15  
 Main lobe magnitude = 14.0 dB  
 Main lobe direction = 0.0 deg.  
 Angular width (3 dB) = 36.0 deg.  
 Side lobe level = -13.3 dB