



Coaxial RF Termination

RFT1825S2

DC-18 GHz, SMA Male, 25 Watts

Rev 3

Electrical

Impedance	50 ohm
Frequency Range	DC-18 GHz
VSWR	1.3 max
Input Avg Power	25W@ 25°C ambient, derating linearly to 2.5W at 100°C
Peak Power	500W (5 micro-sec pulse width, 2.5% duty cycle)

Mechanical

Connector Body	Passivated stainless steel
Center Contact	Gold plated brass
Heat Sink	Black anodized aluminum

Environmental

Operating Temp	-55°C to 100°C
Storage Temp	-55°C to 125°C
RoHS	Compliant

Dimensions(mm)

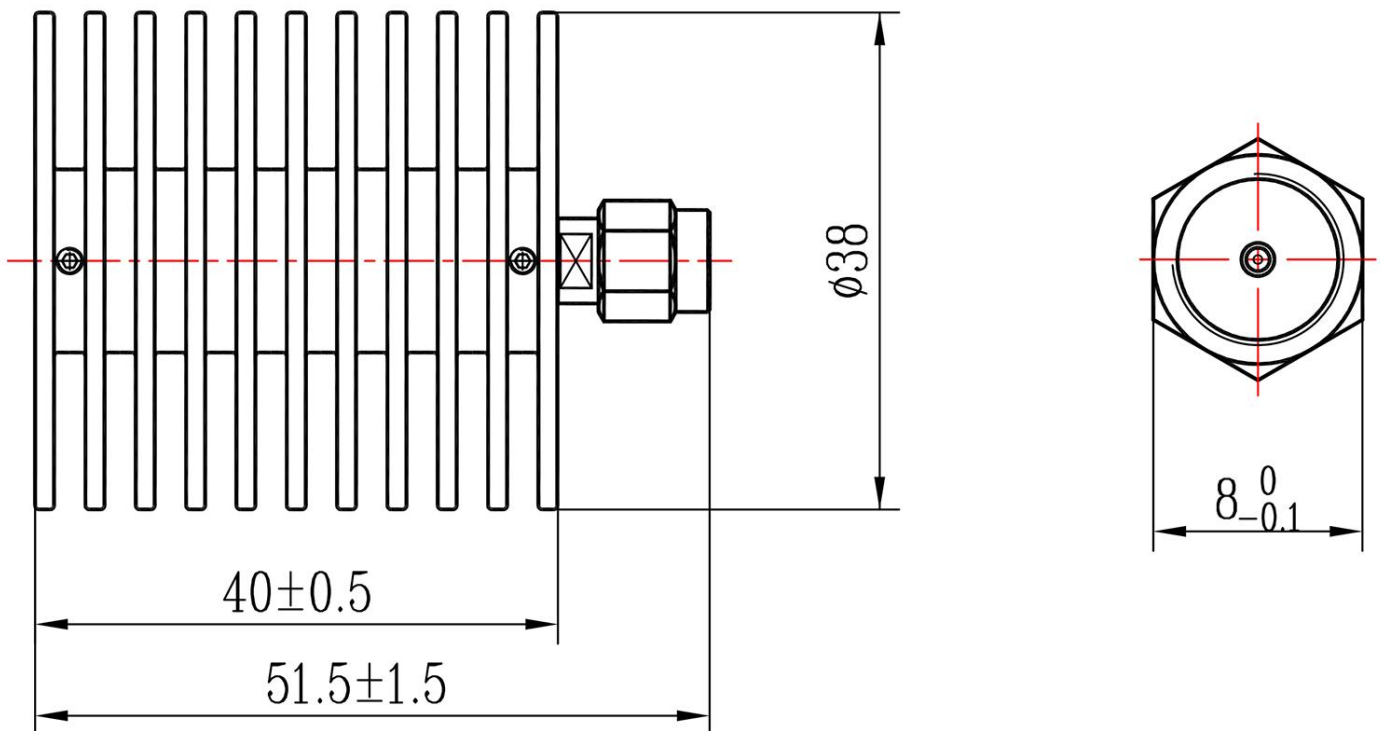

Notes

1. Customized outlines and optimal VSWR available.
2. To maintain best performance, recommended to use fan to keep the case temperature under 85°C.