



Electrical

Impedance	50 ohm
Frequency Range	DC-12.4 GHz
VSWR	1.35 max
Input Avg Power	50W@ 25°C ambient, derating linearly to 5W at 100°C
Peak Power	500W (5 micro-sec pulse width, 5% duty cycle)

Mechanical

Connector Body	Ternary alloy plated brass
Center Contact	Gold plated brass
Heat Sink	Black anodized aluminum

Environmental

Operating Temp	-55°C to 100°C
Storage Temp	-55°C to 125°C
RoHS	Compliant

Dimensions(mm)

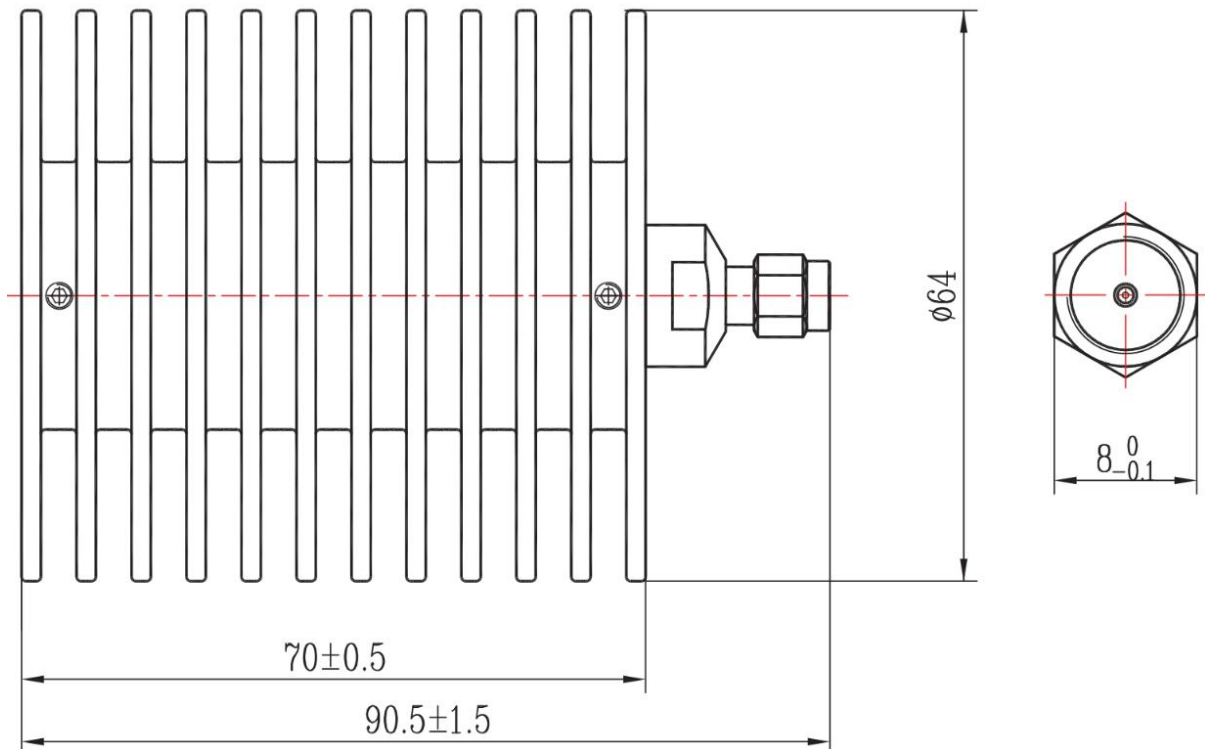

Notes

1. Customized outlines and optimal VSWR available.
2. To maintain best performance, recommended to use fan to keep the case temperature under 85°C.