



Electrical

| | |
|------------------------|---|
| Impedance | 50 ohm |
| Frequency Range | DC-8.5 GHz |
| VSWR | 1.2 max |
| Input Avg Power | 10W@ 25°C ambient, derating linearly to 1W at 100°C |
| Peak Power | 500W (5 micro-sec pulse width, 1% duty cycle) |

Mechanical

| | |
|-----------------------|----------------------------|
| Connector Body | Passivated stainless steel |
| Center Contact | Gold plated brass |
| Heat Sink | Black anodized aluminum |

Environmental

| | |
|-----------------------|----------------|
| Operating Temp | -55°C to 100°C |
| Storage Temp | -55°C to 125°C |
| RoHS | Compliant |

Dimensions(mm)

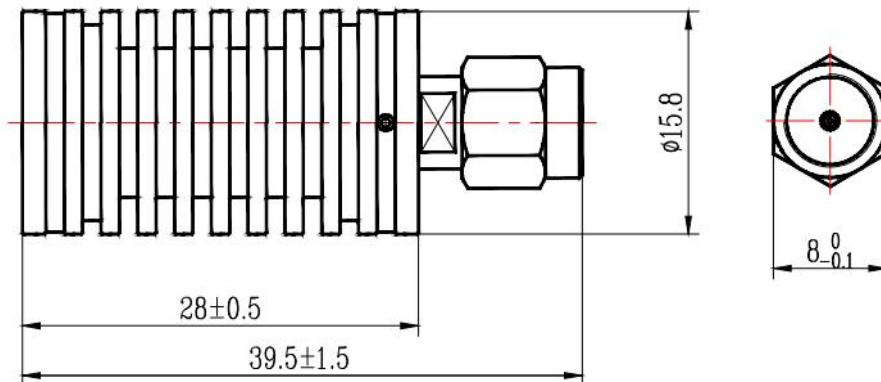

Notes

1. Customized outlines and optimal VSWR available.
2. To maintain best performance, recommended to use fan to keep the case temperature under 85°C.