

Coaxial RF Termination

RFT0602N2

DC-6 GHz, N Male, 2 Watts



Rev 3

Electrical

Impedance	50 ohm
Frequency Range	DC-6 GHz
VSWR	1.2 max
Input Avg Power	2W@ 25°C ambient, derating linearly to 0.2W at 100°C
Peak Power	200W (5 micro-sec pulse width, 0.5% duty cycle)

Mechanical

Connector Body	Ternary alloy plated brass
Center Contact	Gold plated brass
Heat Sink	N/A

Environmental

Operating Temp	-55°C to 100°C
Storage Temp	-55°C to 125°C
RoHS	Compliant

Dimensions(mm)

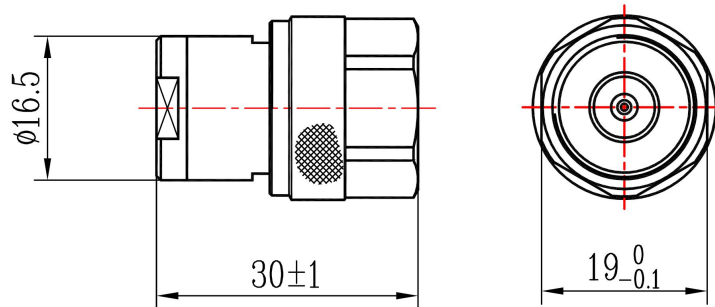

Notes

1. Customized outlines and optimal VSWR available.