



Electrical

Impedance	50 ohm			
Frequency Range	DC-6 GHz			
VSWR	1.2 max			
Input Avg Power	25W@ 25°C ambient, derating linearly to 2.5W at 100°C			
Peak Power	500W (5 micro-sec pulse width, 2.5% duty cycle)			
Direction	Bidirectional, SMA female to SMA male (other configurations available)			

Attenuation(dB)	1-10	11-20	21-30	31-40
Accuracy(dB)	±0.5	±0.6	±0.8	±0.8

Mechanical

Connector Body	Passivated stainless steel
Heat Sink	Black anodized aluminum
Center Contact	Gold plated beryllium copper/brass
Net Weight	Approx 70 g

Environmental

Operating Temperature	-55°C to 100°C
Storage Temperature	-55°C to 125°C
RoHS	Compliant
Temperature Coefficient	<0.0004 dB/dB/°C

Dimensions(mm)

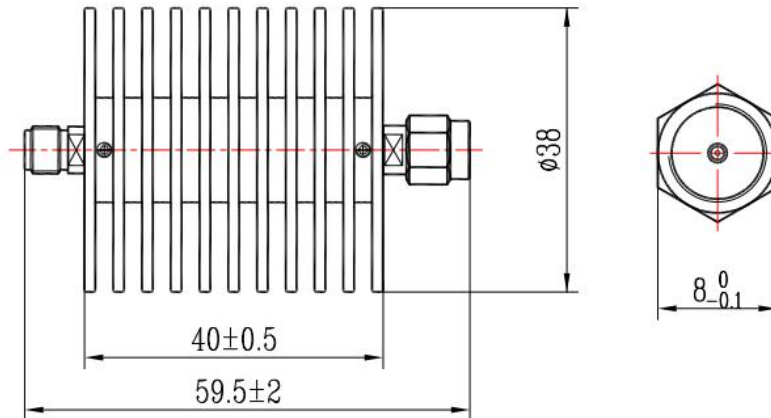

Notes

- 1.To maintain best performance, recommended to use fan to keep the case temperature under 85°C.
- 2.Customized dB values, outlines and optimal accuracy/VSWR available.

Model Description

RFHB06XXSC25

- 1.XX for dB value: 06=6dB,30=30dB
- 2.Code for connector configuration:
A=female for two ends; B=male for two ends
C=female for one end and male for the other.