



**Electrical**

<b>Impedance</b>	50 ohm			
<b>Frequency Range</b>	DC-6 GHz			
<b>VSWR</b>	1.2 max			
<b>Input Avg Power</b>	2W@ 25°C ambient, derating linearly to 0.2W at 100°C			
<b>Peak Power</b>	200W (5 micro-sec pulse width, 0.5% duty cycle)			
<b>Direction</b>	Bidirectional, 4.3-10 female to 4.3-10 male (other configurations available)			

<b>Attenuation(dB)</b>	1-6	7-10	11-20	21-30
<b>Accuracy(dB)</b>	±0.3	±0.5	±0.6	±0.8

**Mechanical**

<b>Connector Body</b>	Ternary alloy plated brass
<b>Heat Sink</b>	N/A
<b>Center Contact</b>	Gold plated beryllium copper/brass
<b>Net Weight</b>	Approx 60 g

**Environmental**

<b>Operating Temperature</b>	-55°C to 100°C
<b>Storage Temperature</b>	-55°C to 125°C
<b>RoHS</b>	Compliant
<b>Temperature Coefficient</b>	<0.0004 dB/dB/°C

**Dimensions(mm)**

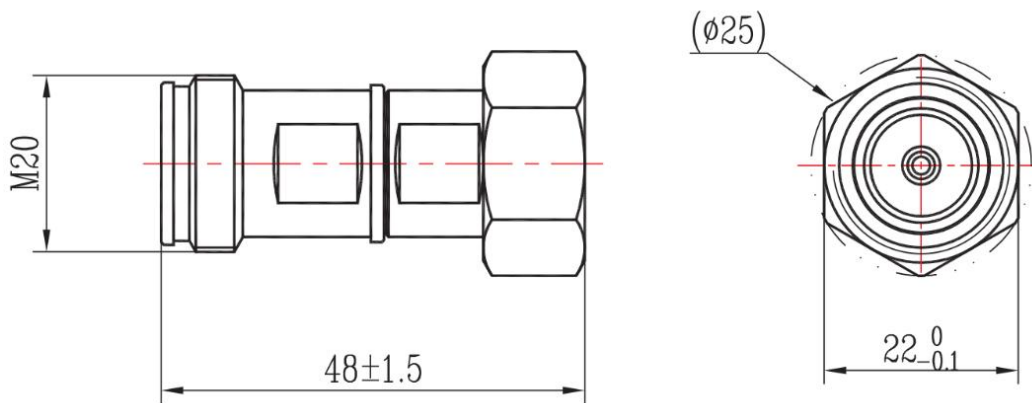

**Notes**

1. Customized dB values, outlines and optimal accuracy/VSWR available.

**Model Description**

**RFHB06XX4310C2**

1. XX for dB value: 06=6dB, 30=30dB

2. Code for connector configuration:

A=female for two ends; B=male for two ends

C=female for one end and male for the other.