



**Electrical**

<b>Impedance</b>	50 ohm			
<b>Frequency Range</b>	DC-4 GHz			
<b>VSWR</b>	1.2 max			
<b>Input Avg Power</b>	25W@ 25°C ambient, derating linearly to 2.5W at 100°C			
<b>Peak Power</b>	800W (5 micro-sec pulse width, 1.5% duty cycle)			
<b>Direction</b>	Bidirectional, N female to N male (other configurations available)			

<b>Attenuation(dB)</b>	1-10	11-20	21-30	40,50
<b>Accuracy(dB)</b>	±0.4	±0.5	±0.6	±0.7

**Mechanical**

<b>Connector Body</b>	Ternary alloy plated brass
<b>Heat Sink</b>	Black anodized aluminum
<b>Center Contact</b>	Gold plated beryllium copper/brass
<b>Net Weight</b>	Approx 140 g

**Environmental**

<b>Operating Temperature</b>	-55°C to 100°C
<b>Storage Temperature</b>	-55°C to 125°C
<b>RoHS</b>	Compliant
<b>Temperature Coefficient</b>	<0.0004 dB/dB/°C

**Dimensions(mm)**

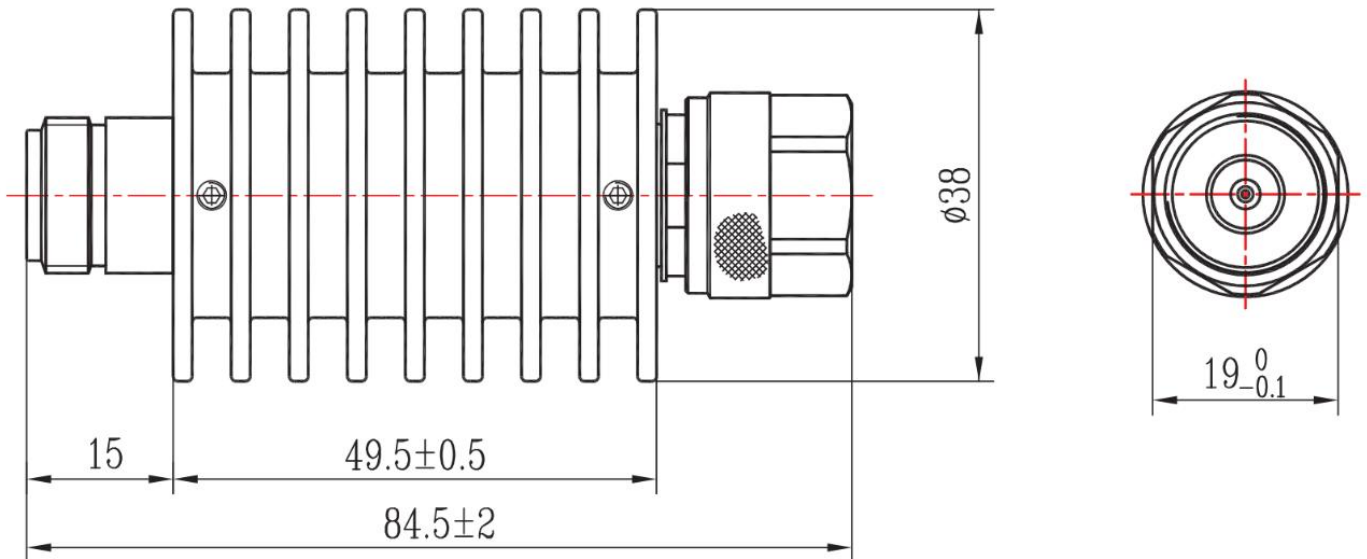

**Notes**

- 1.To maintain best performance, recommended to use fan to keep the case temperature under 85°C.
- 2.Customized dB values, outlines and optimal accuracy/VSWR available.

**Model Description**

**RFHB04XXNC25**

- 1.XX for dB value: 06=6dB,30=30dB
- 2.Code for connector configuration:  
A=female for two ends; B=male for two ends  
C=female for one end and male for the other.