



Electrical

Impedance	50 ohm				
Frequency Range	DC-12.4 GHz				
VSWR	1.35 max				
Input Avg Power	100W@ 25°C ambient, derating linearly to 10W at 100°C				
Peak Power	1kW (5 micro-sec pulse width, 5% duty cycle)				
Direction	Unidirectional, N male input, N female output (other configurations available)				

Attenuation(dB)	6-10	20	30	40	50,60
Accuracy(dB)	±1.2	±0.9	±1.0	±1.0	±1.1

Mechanical

Connector Body	Ternary alloy plated brass
Heat Sink	Black anodized aluminum
Center Contact	Gold plated beryllium copper/brass
Net Weight	Approx 720 g

Environmental

Operating Temperature	-55°C to 100°C
Storage Temperature	-55°C to 125°C
RoHS	Compliant
Temperature Coefficient	<0.0004 dB/dB/°C

Dimensions(mm)

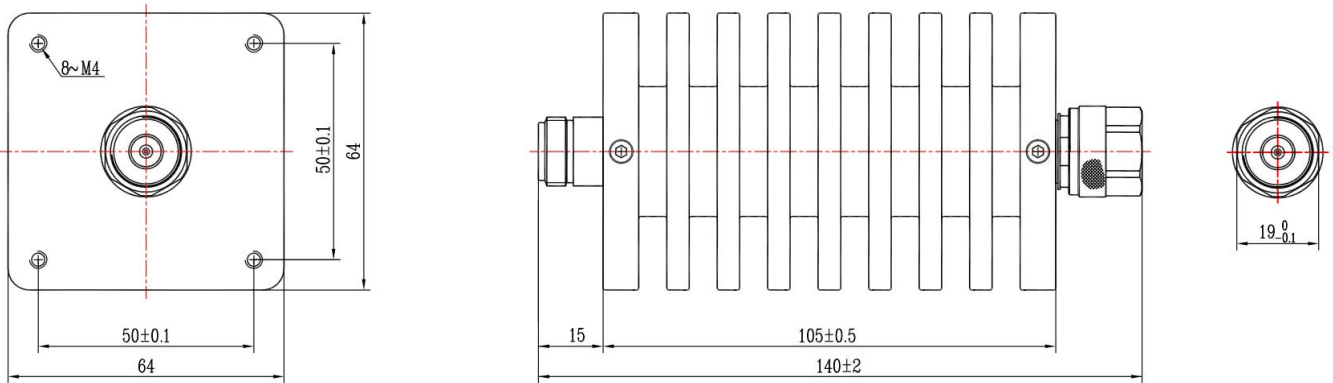

Notes

1. Always pay attention to the direction of attenuators.
2. To maintain best performance, recommended to use fan to keep the case temperature under 85°C.
3. Customized dB values, outlines and optimal accuracy/VSWR available.

Model Description

RFH12XXND100-S

1. XX for dB value: 06=6dB, 30=30dB
2. Code for connector configuration:
 A=female for two ends; B=male for two ends
 C=female for input and male for output;
 D=male for input and female for output.